

1 LANDSCAPE IRRIGATION PLAN

1/16" = 1' 0"

0 4 8 12 16 32 48 64 FEET



Printed / Revised
01.14.12 CONSTRUCTION REQUIREMENTS

LANDSCAPE IRRIGATION PLAN

Hale Uhiwai Nalu Addition
91-1078 Yorktown Street
Kapolei, HI 96707



TOGAWA SMITH MARTIN
INCORPORATED
444 S Flower Street - Suite 1220
Los Angeles, California 90071
213.614.8050
213.614.8051 fax
www.tsminc.com

Job No.: 2011421
Date: 1/12/12
Scale: 1/16" = 1'
Sheet No.:

L301

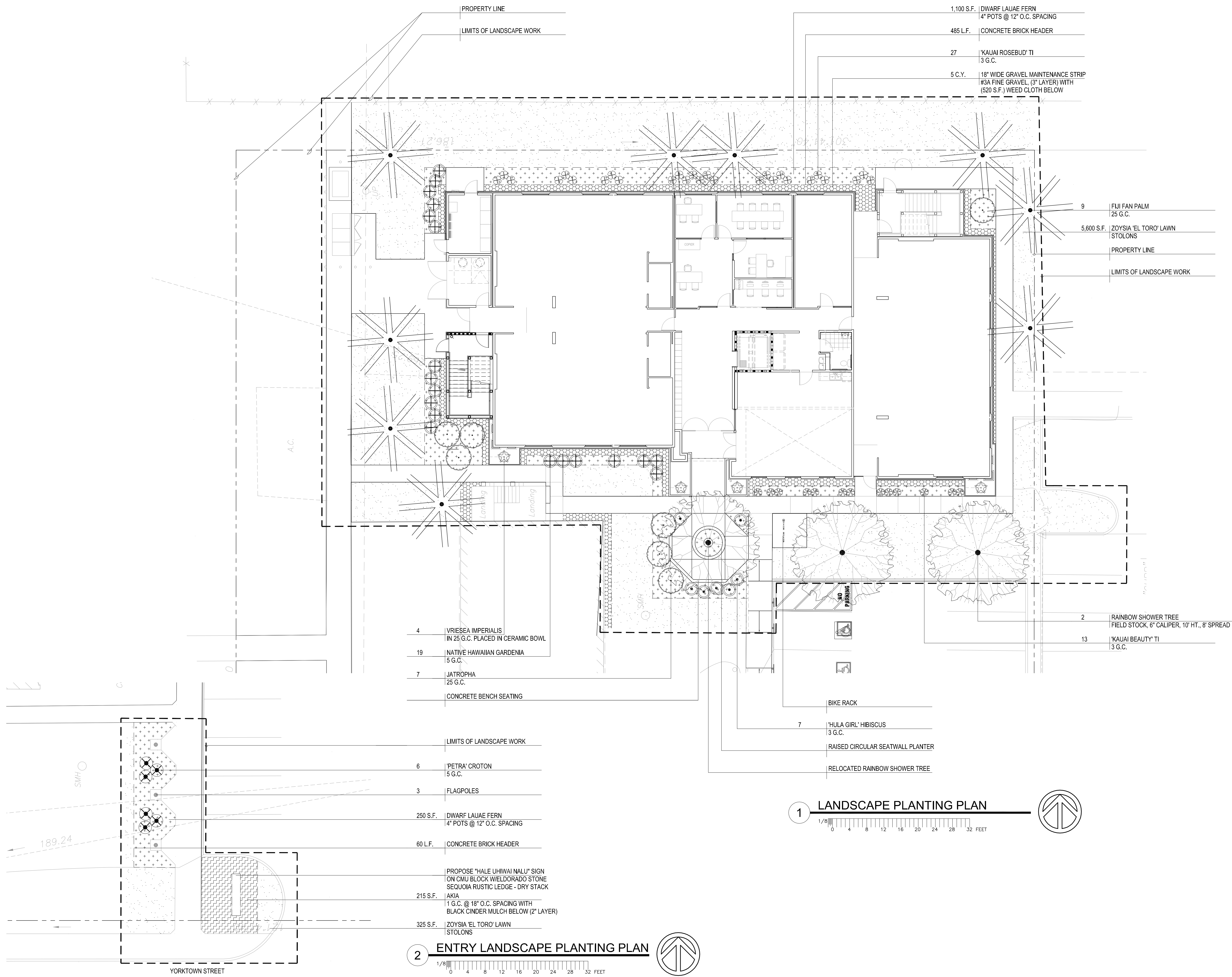

- 1,100 S.F. DWARF LAUAE FERN
4\"/>
- 485 L.F. CONCRETE BRICK HEADER
- 27 'KAUAI ROSEBUD' TI
3 G.C.
- 5 C.Y. 18\"/>

- 9 FIJI FAN PALM
25 G.C.
- 5,600 S.F. ZOYSIA 'EL TORO' LAWN
STOLONS

- 4 VRIESEA IMPERIALIS
IN 25 G.C. PLACED IN CERAMIC BOWL
- 19 NATIVE HAWAIIAN GARDENIA
5 G.C.
- 7 JATROPHA
25 G.C.
- CONCRETE BENCH SEATING

- 2 RAINBOW SHOWER TREE
FIELD STOCK, 6\"/>
- 13 'KAUAI BEAUTY' TI
3 G.C.

- LIMITS OF LANDSCAPE WORK
- 6 'PETRA' CROTON
5 G.C.
- 3 FLAGPOLES
- 250 S.F. DWARF LAUAE FERN
4\"/>
- 60 L.F. CONCRETE BRICK HEADER

1 LANDSCAPE PLANTING PLAN

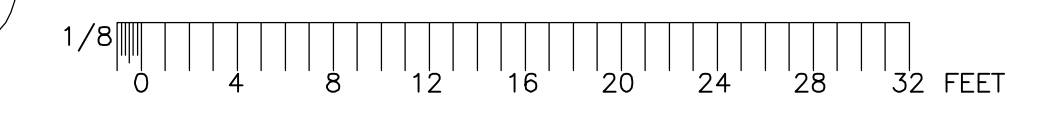

2 ENTRY LANDSCAPE PLANTING PLAN

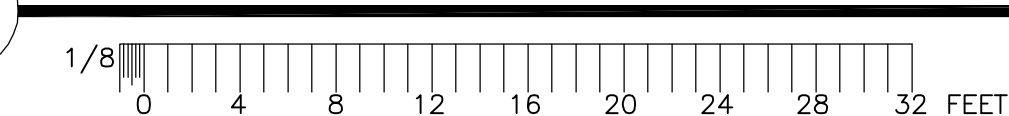

LANDSCAPE PLANTING PLAN

Hale Uhiwai Nalu Addition

91-1078 Yorktown Street
Kapolei, HI 96707
Download by:
CLOUDBREAK HAWAII, LLC
414 South Mendenhall Avenue
Honolulu, HI 96813
Tel: 810.688.9100

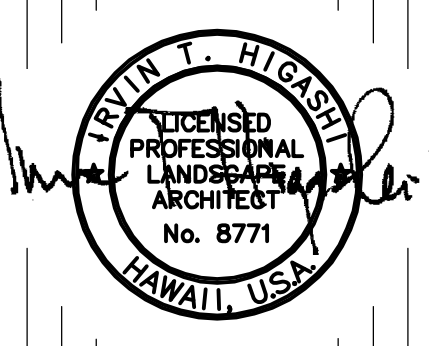

444 S Flower Street - Suite 1220
Los Angeles, California 90071
213.614.6050
213.614.6051 fax
www.tsminc.com

Job No.: 2011421
Date: -
Scale: 1/8" = 1'-0"
Sheet No.:

PLANT LIST

BOTANICAL NAME
COMMON NAME

TREES AND PALMS	SIZE AND CONDITIONS	QUANTITY
CASSIA JAVANICA X C. FISTULA RAINBOW SHOWER TREE	EXISTING TO BE RELOCATED	1
CASSIA JAVANICA X C. FISTULA RAINBOW SHOWER TREE	FIELD STOCK 10' HIGH, 8' SPREAD, 6" CAL.	2
JATROPHA HASTATA JATROPHA	25 G.C. 6' HIGH, 4' SPREAD, 1-1/2" CAL.	7
PRITCHARDIA PACIFICA FIJI FAN PALM	25 G.C. 8' HIGH	9

SHRUBS	SIZE AND CONDITIONS	QUANTITY
CORDYLINE SPP. 'KAUAI BEAUTY' TI	3 G.C.	13
CORDYLINE SPP. 'KAUAI ROSEBUD' TI	3 G.C.	27
CROTON SPP. 'PETRA' CROTON	5 G.C.	6
GARDENIA BRIGHAMII NATIVE HAWAIIAN GARDENIA	5 G.C.	19
HIBISCUS SPP. 'HULA GIRL' HIBISCUS	3 G.C.	7
VRIESEA IMPERIALIS VRIESEA	PLANTED IN 25 G.C. BOWL	4

GROUND COVER / GRASS	SIZE AND CONDITIONS	QUANTITY
MICROSORIUM DIVERSIFOLIUM DWARF LAUAE FERN	S.F. 4" POTS @ 12" O.C.	1,350
WIKSTROEMIA UVA URSI AKIA	S.F. 1 G.C. @ 18" O.C.	215
ZOYSIA JAPONICA ZOYSIA 'EL TORO'	S.F. STOLONS	5,925

MISCELLANEOUS	SIZE AND CONDITIONS	QUANTITY
BLACK CINDER	C.Y., 2" LAYER	2
CONCRETE BRICK HEADER	L.F.	545
IMPORTED SCREENED TOPSOIL W/ AMENDMENTS	C.Y., 4" LAYER	93
IRRIGATION SYSTEM	S.F.	7,490
MAINTENANCE PERIOD	MONTHS	3
WEED CLOTH	S.F.	520
#3A FINE GRAVEL	C.Y., 3" LAYER	5

GENERAL NOTES

- CONTRACTOR SHALL VERIFY LOCATIONS OF ALL EXISTING UTILITY LINES PRIOR TO CONSTRUCTION OPERATIONS. ANY UTILITY LINES DAMAGED BY CONTRACTOR'S OPERATIONS SHALL BE REPAIRED AT CONTRACTOR'S EXPENSE.
- CONTRACTOR SHALL NOTIFY ARCHITECT OF ANY DISCREPANCIES PRIOR TO COMMENCEMENT OF WORK.
- THE PLANT LIST QUANTITIES ARE APPROXIMATE AND SHOULD SERVE ONLY AS A GUIDELINE FOR THE CONTRACTOR. ALL WORK INDICATED ON THE DRAWINGS BY NOTES SHALL BE PROVIDED WHETHER OR NOT SPECIFICALLY MENTIONED IN THE PLANT LIST. PLANTS AND GROUND COVERS SHALL BE FURNISHED IN QUANTITIES AS REQUIRED TO COVER THE AREAS INDICATED ON THE PLANS AS THE SPACE NOTED. THE CONTRACTOR SHALL VERIFY ALL QUANTITIES BEFORE BIDDING.
- CONTRACTOR TO CHECK AND VERIFY ALL DIMENSIONS AND CONDITIONS ON PROJECT SITE PRIOR TO CONSTRUCTION.
- CONTRACTOR TO PROVIDE DUST CONTROL AT ALL TIMES DURING CONSTRUCTION.

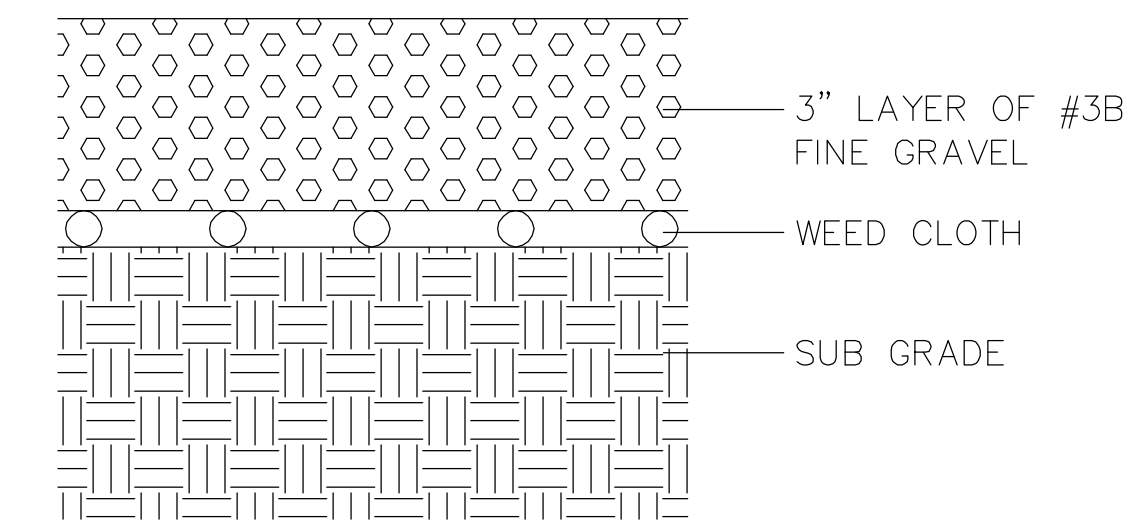

7 WEED CLOTH DETAIL

NO SCALE

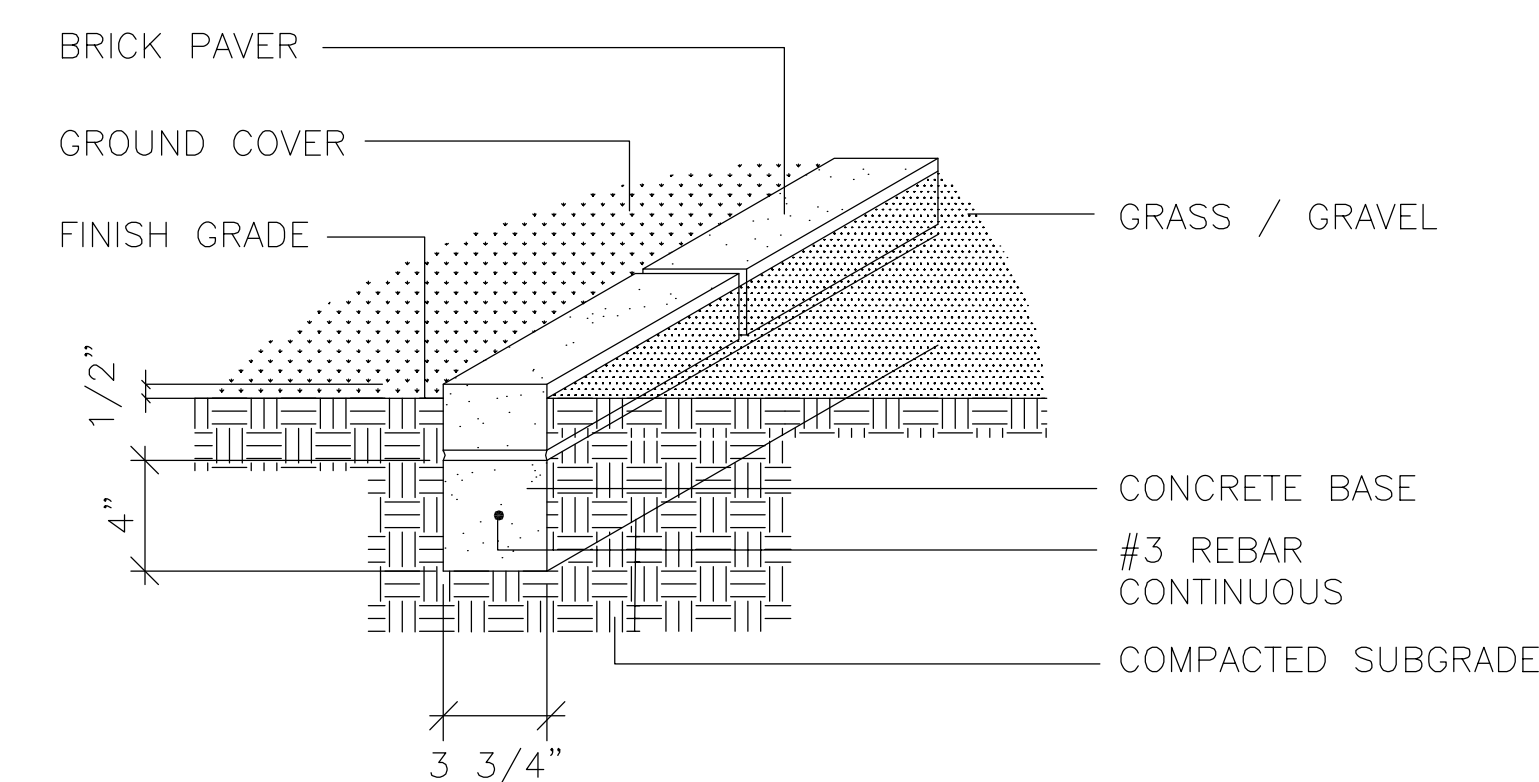

6 CONCRETE BRICK HEADER DETAIL

NO SCALE

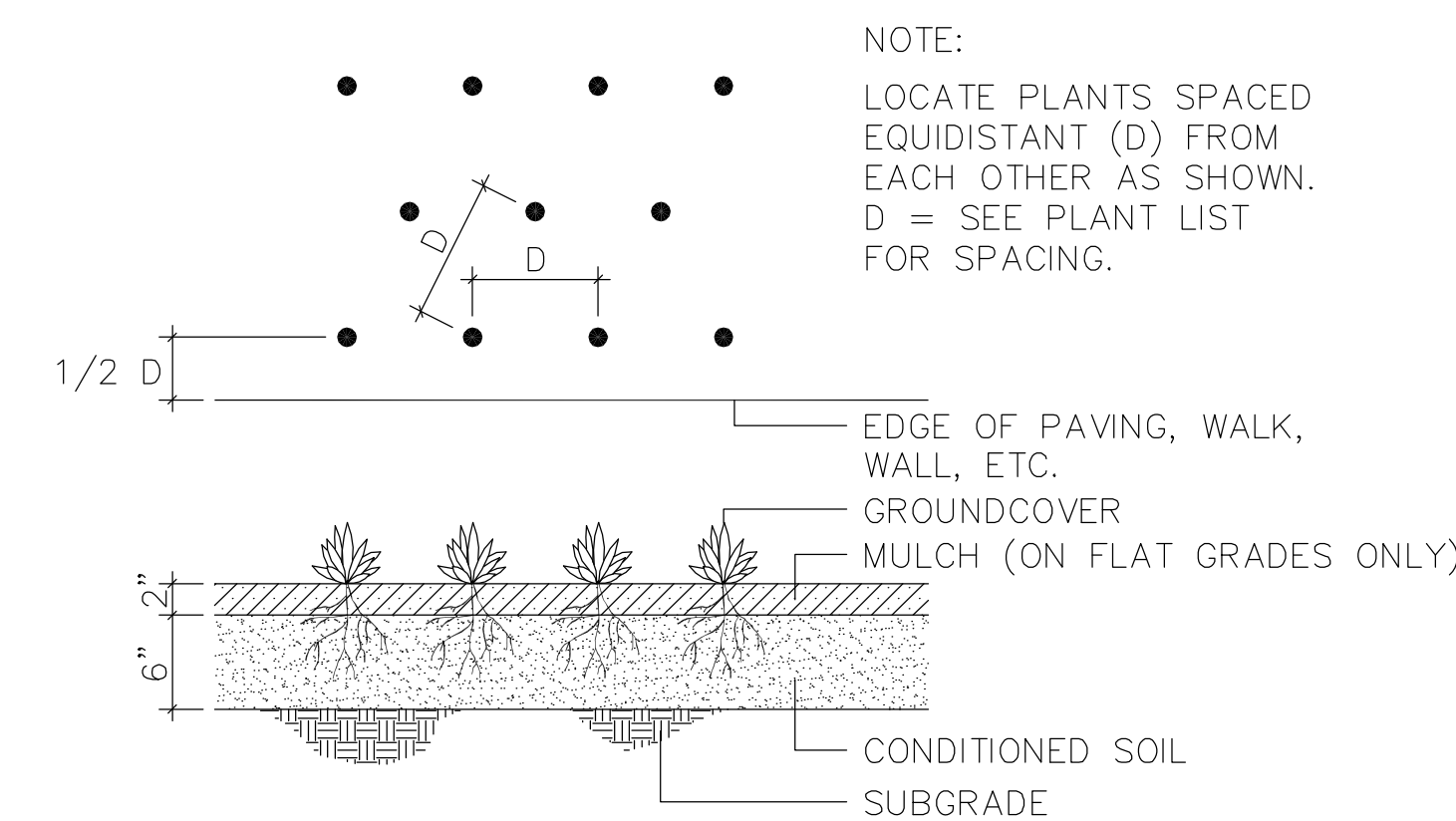

5 GROUND COVER DETAIL

NO SCALE

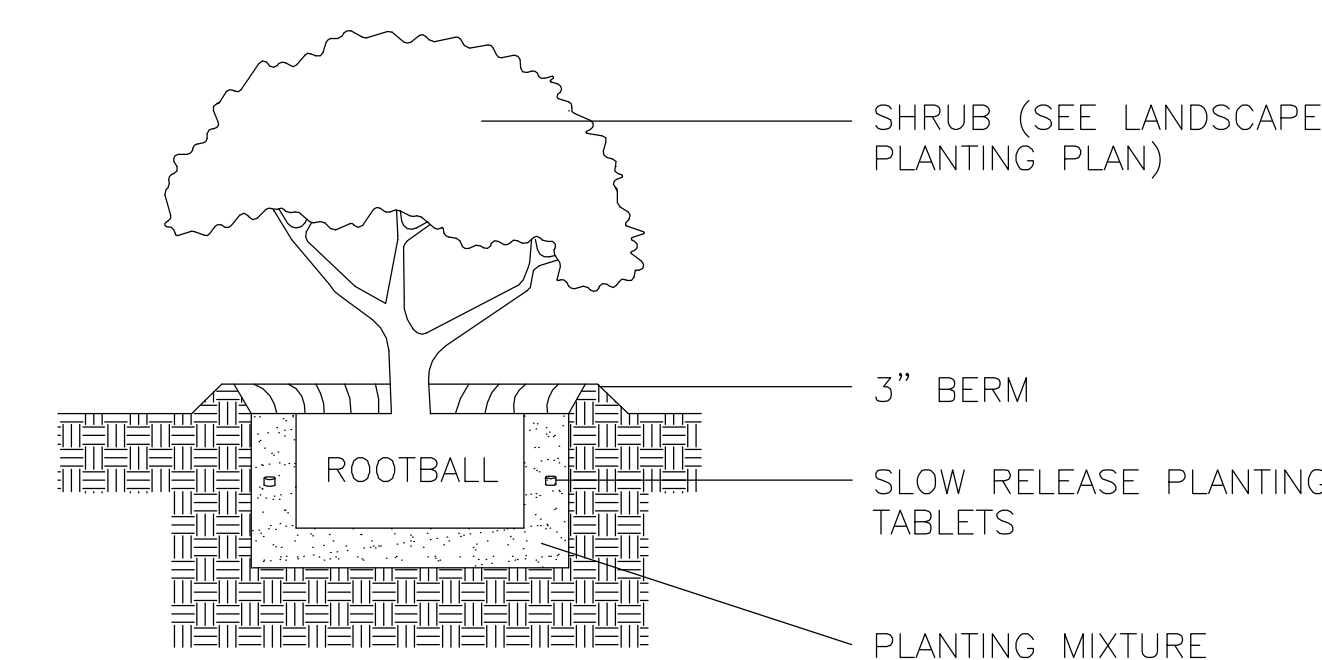

4 SHRUB PLANTING DETAIL

NO SCALE

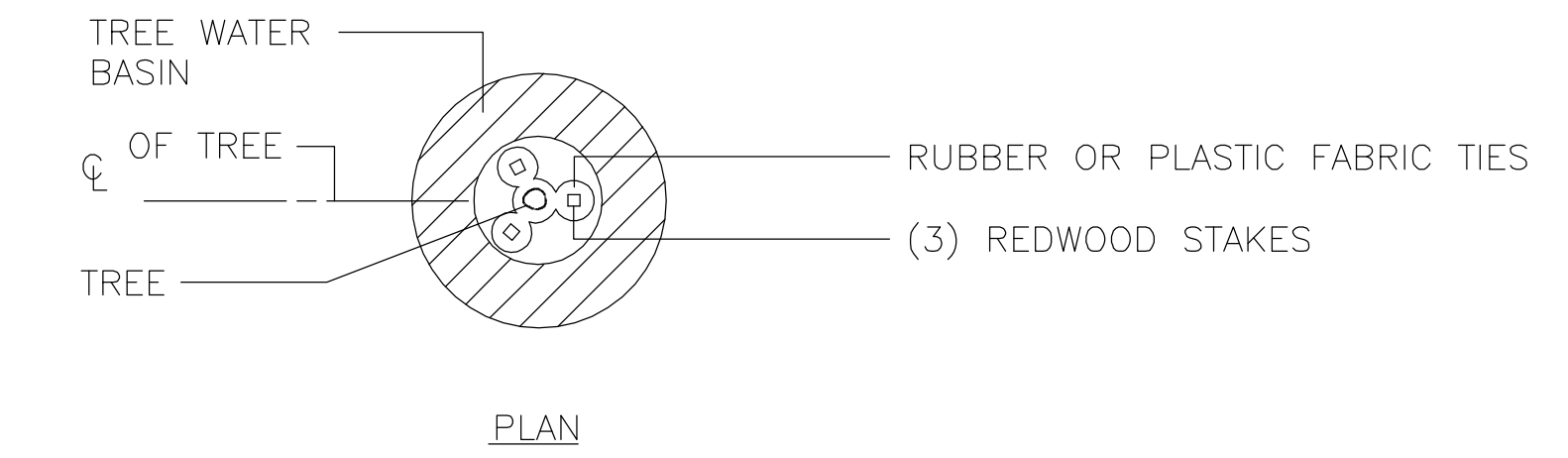

PLAN

- NOTE: 1. RAKE OUT BERM AT END OF MAINTENANCE PERIOD.
2. WHEN REFILLING HOLE DO NOT LEAVE ANY AIRSPACE; WATER HEAVILY TO INSURE THAT SOIL SETTLES AROUND ROOTS
3. TRUNK MUST BE PROTECTED FROM ROPE SLING BURNS AND ABRASIONS DURING MOVING

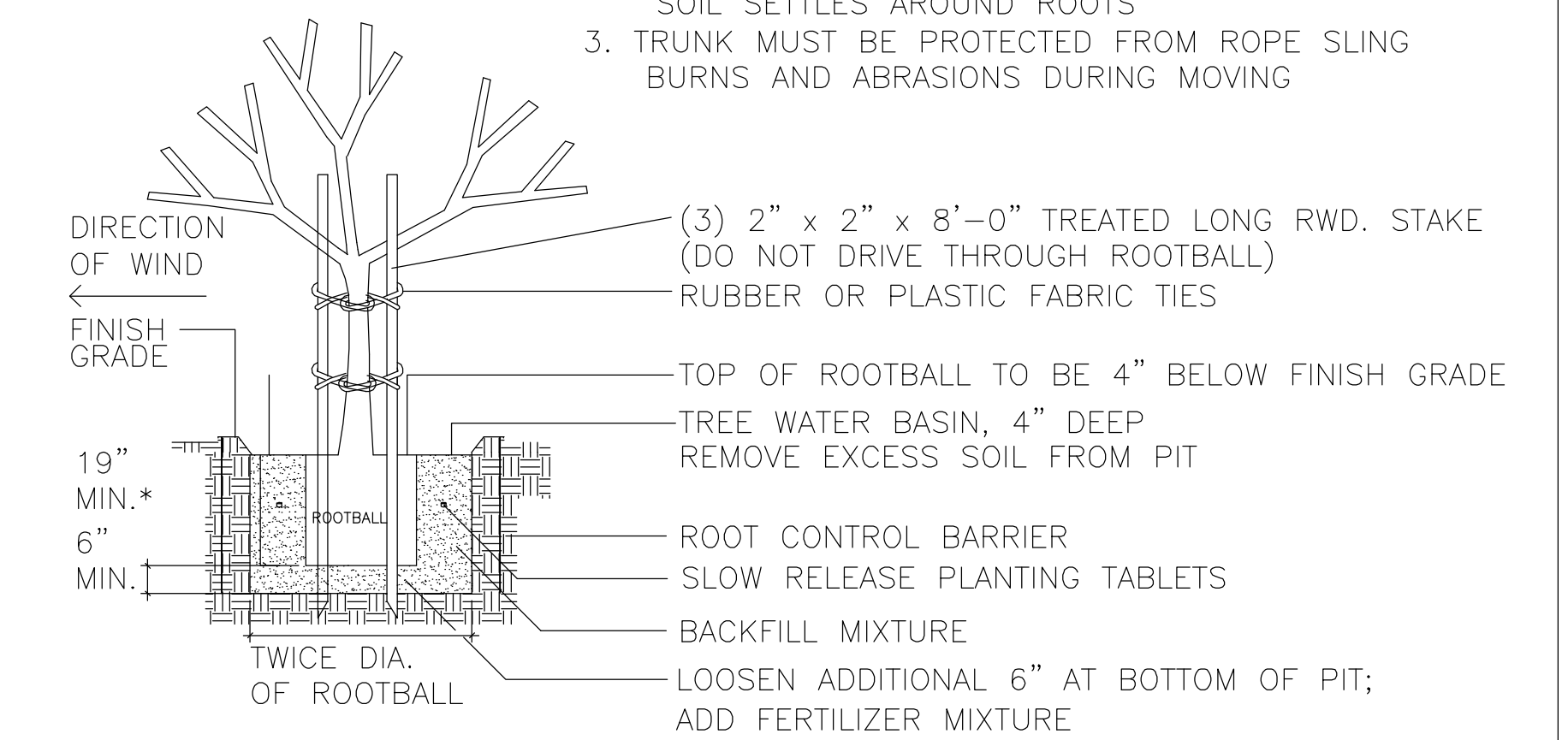

*UNLESS DESIGNATED OTHERWISE ON PLAN.

3 25 G.C. TREE PLANTING DETAIL

NO SCALE

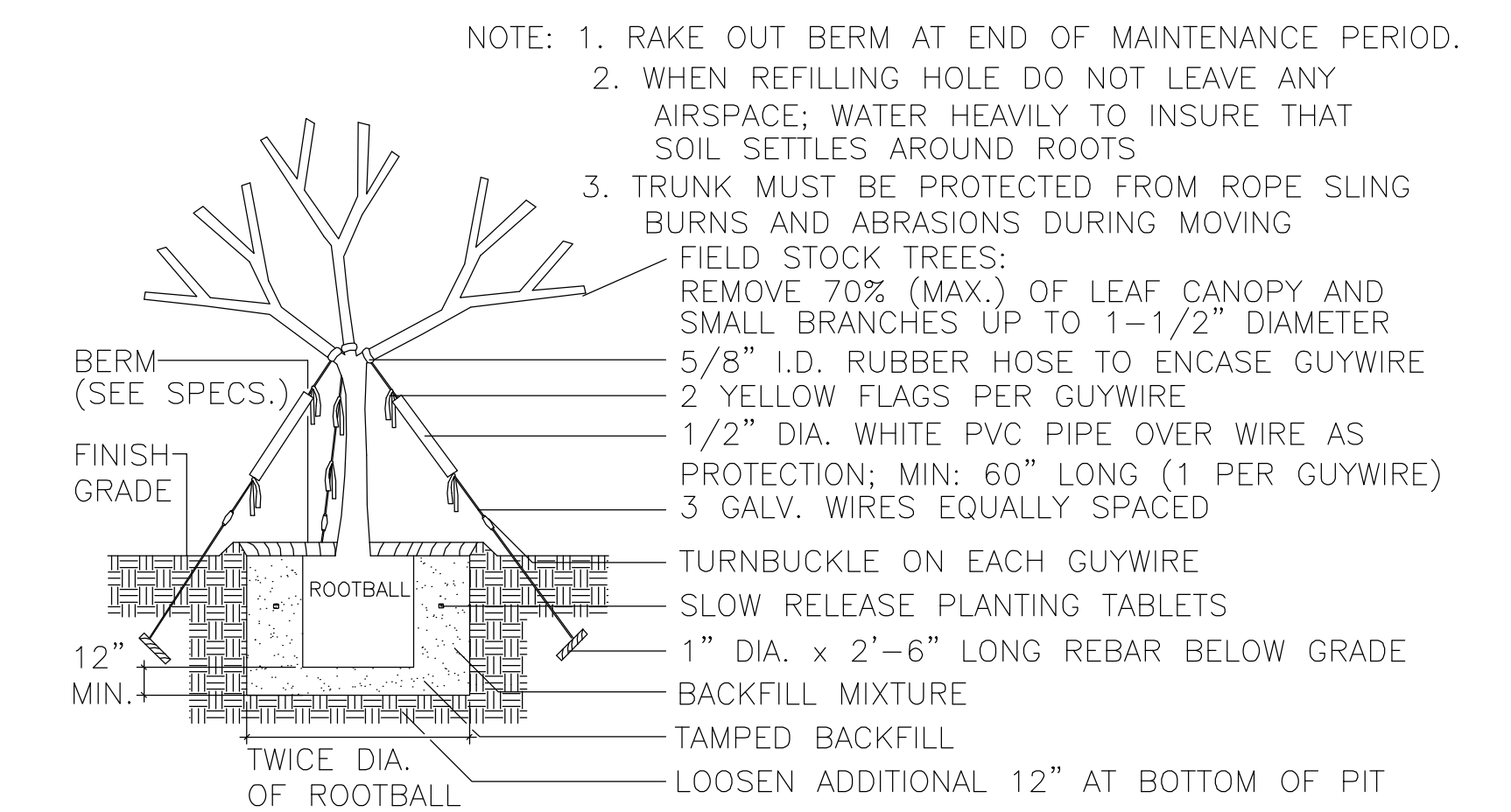

2 FIELD STOCK TREE PLANTING DETAIL

NO SCALE

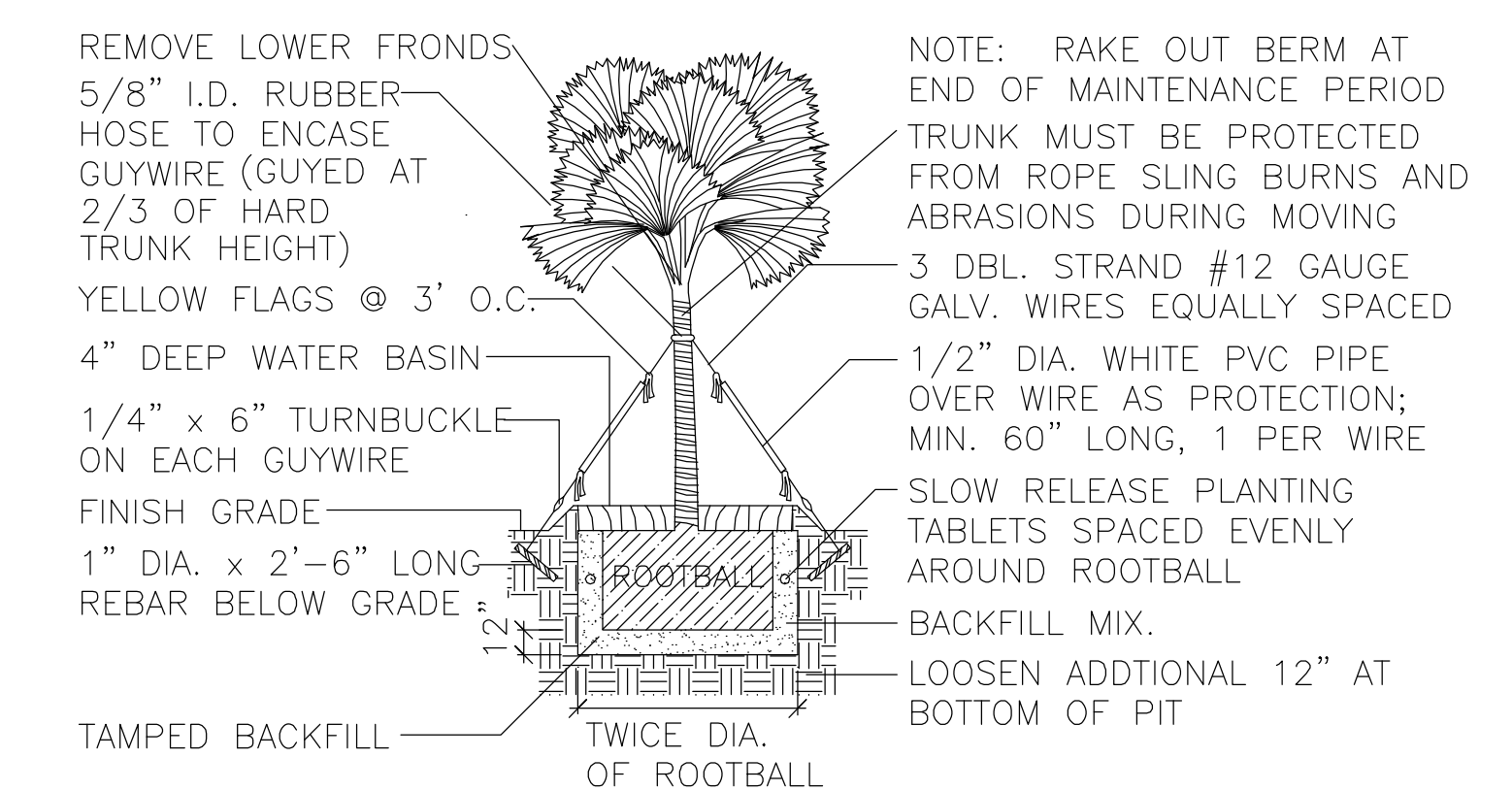

1 FAN PALM PLANTING DETAIL

NO SCALE

Printer/Revised
09.14.12 Construction Documents

PLANT LIST, NOTES AND DETAILS

Hale Uhiwai Natu Addition
91-1078 Yorktown Street
Kapolei, HI 96707
Download by:
CLOUDBREAK HAWAII LLC
414 South Mendenhall Avenue
Honolulu, HI 96813
Tel: 810.688.9100

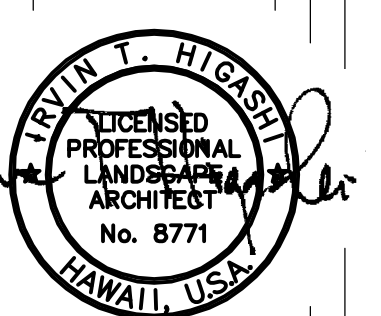

TOGAWA
SMITH
MARTIN
INCORPORATED

444 S Flower Street - Suite 1220
Los Angeles, California 90071
213.614.6050
213.614.6051 fax
www.tsminc.com

Job No.: 2011421
Date: NO SCALE
Scale: NO SCALE
Sheet No.:

L201